

15.0 inch Panel PC Series-2B2 Intel® Core™ i3 / i5 / i7 12th Gen.



- 15.0" TFT LCD, 1024 x 768
- Processor: Intel® Core™ i3 / i5 / i7 12th Gen.
- Die-cast aluminum housing
- Frameless design, IP65 front side
- Fanless design

<https://www.wachendorff-electronics.comPPC005-150B2>

Description

Wachendorff Panel PC Series-2

The Wachendorff Series-2 Panel PCs are available in display sizes ranging from 10" to 21.5" and can be equipped with projected capacitive, resistive or no touch. The projected capacitive touch display enables multi-touch operation with an appropriate operating system. If pressure-sensitive operation is required (e.g. with gloves), the resistive touch is the right choice. You can choose from a variety of different processors, from the energy-efficient Intel® Celeron® J4125 to a 12th generation Intel® Core™ i7. Integrate up to 64 GB of RAM to meet the most demanding requirements. Particularly noteworthy is the extremely narrow display edge, which enables a virtually frameless design. The housings are IP65 rated at the front and have a very compact and robust design thanks to the specially constructed aluminum housing. The unique fanless thermal design of the die-cast aluminum housing enables effective temperature control.

Product details

Power supply:	Hollow plug 5.5 x 2.5 mm: 12 VDC to 36 VDC Screw terminal: 12 VDC to 36 VDC
Power consumption:	Typical power consumption: 18 W Maximum power consumption: 70 W
Display:	15.0" TFT LCD
Resolution:	1024 x 768 pixels
Aspect ratio:	4:3
Brightness:	300 cd/m ² 1000 cd/m ² (High Brightness)
Colors:	16,7 M
Reading angle:	89/89/89/89 (L/R/U/D)
Touch screen:	<ul style="list-style-type: none"> • Projected capacitive touch • Resistive touch • without touch
Glass hardness:	<ul style="list-style-type: none"> • 6H Projected capacitive touch • 3H Resistive touch • 7H without touch
Processor:	Intel® Core™ i3-1215U (4.4 GHz), Intel® Core™ i5-1235U (4.4 GHz), Intel® Core™ i7-1255U (4.7 GHz)
RAM:	Max. 32GB DDR4
SSD/HDD:	Max. 1 TB

Interfaces:	USB: 2 x USB 2.0 type A, 2 x USB 3.0 type A Serial DB-9: 1x RS-232 12-pin screw terminal: 1x RS-485, 1x RS-232, 5x GPIO Ethernet: 2x RJ-45 Gigabit Ethernet, galvanically isolated Display: 1x HDMI, 1x VGA Audio: 1x audio out, 3.5 mm jack Sim Card Slot: Standard SIM (without function as standard) WLAN: 1x 802.11 abgn/ac/d/e/i/h/w Bluetooth: 1x Bluetooth 4.0
Expansion slots:	None
Housing:	Die-cast aluminum housing
Assembly:	VESA 75 x 75, VESA 100 x 100 Panel mounting
Protection class:	IP65 on the front
Dimensions (WxHxD):	365.5 mm x 289.5 mm x 64.5 mm
Weight:	approx. 4.6 kg
Certifications:	CE, RoHS, FCC, REACH
Ambient conditions:	Operation: -10 °C to +60 °C, Optional WT: -20 °C to +70 °C High Brightness: -20 °C to +70 °C Storage: -20 °C to +70 °C Up to 95 % r. h., non-condensing
Operating systems:	Windows® 10 IoT Windows® 11 IoT
Options:	LTE -20 °C to +70 °C (optionally customizable)
Scope of delivery:	1 x device 1 x mounting material
Customs tariff number:	8471 41 00
Manufacturer:	Wachendorff Prozesstechnik GmbH & Co. KG

Products Order no.

PPC005-150B2	15.0 inch Industrial Panel PC Series-2B2, aluminum housing, Intel Core 12th Gen.
--------------	--

Accessories Order no.

PPC-PWRADAP_03_24VDC5A	External power supply unit for Intel Core 12. Gen. Panel-PC, 230VAC to 24VDC, hollow connector and C14 Stecker
PPC-PWRCRD_01	Mains cable / connection cable E+F CEE 7/7 to C13 1.5 m
PPC-Stand_01	Industrial monitor/display stand, VESA 100x100, black
PPC-Stand_02	Industrial monitor/display stand, VESA 100x100, silver
PPC-WALL-VESA-01	VESA wall mount metal, 75 x 75, 100 x100, black, including screw accessory pack

Drawings

Dimensions (mm) and STL file/viewer:

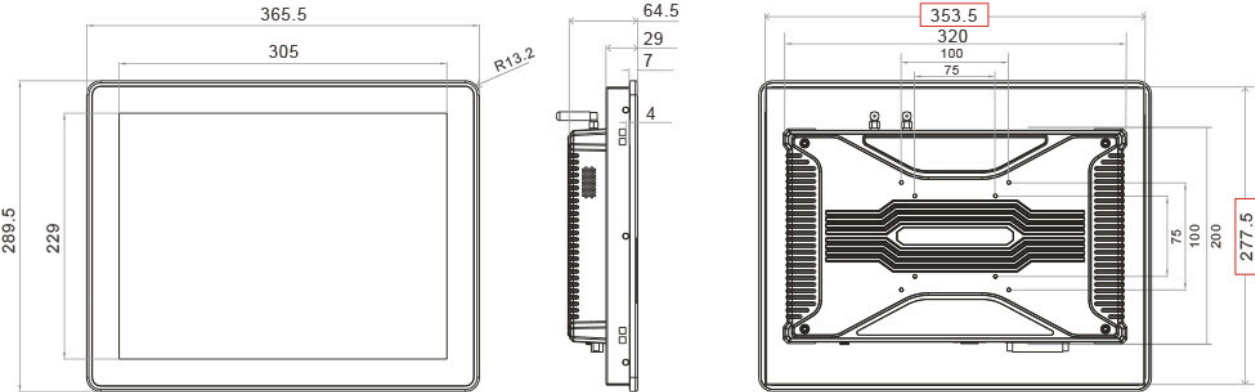

Schnittstellenposition kann abweichen. Für genauere Information bitte die Produktfotos beachten.
Interface position may vary. Please refer to the product photos for more detailed information.



Wachendorff Prozesstechnik GmbH & Co. KG
Industriestrasse 7 • 65366 Geisenheim
Germany

Phone: +49 (0) 67 22 / 99 65 - 20
E-Mail: wp@wachendorff.de
www.wachendorff-prozesstechnik.de

